

EC

ENG Residential Irrigation Controller

Owner's Manual and Programming Instructions.

ESP Programador de Riego Residencial

Manual de Operación e Instrucciones de Programación.

FR Programmeurs EC pour Sites Résidentiels

Manuel de l'utilisateur et instructions de programmation du programmeur.

IT Programmatori EC

Manuale dell'utente ed istruzioni per la programmazione.

DEU Bewässerungssteuerung

Bedienungs- und Montageanleitung.

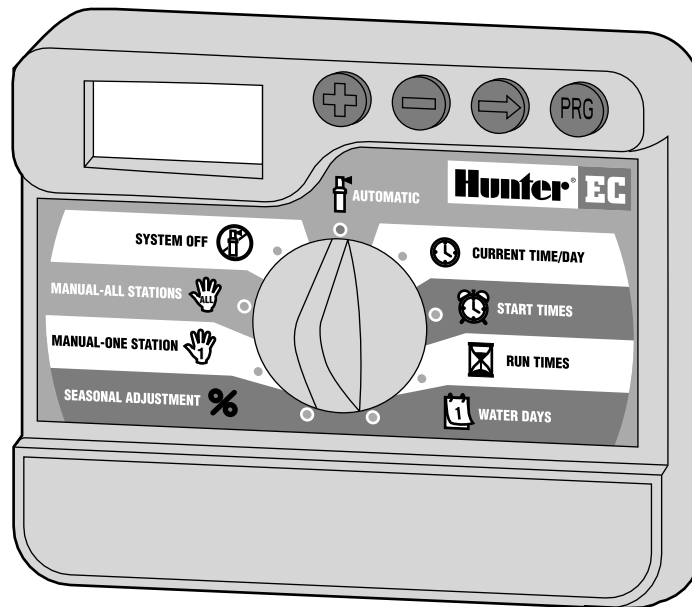

Hunter®

RESIDENTIAL IRRIGATION CONTROLLER



Owner's Manual and Programming Instructions.

TABLE OF CONTENTS







INSTALLATION

- EC Components 1-2
- Mounting the Controller to Wall..... 3
- Connecting Valves and Transformer..... 3-4
- Connecting the Battery..... 4
- Connecting a Master Valve 4
- Connecting a Pump Start Relay 5
- Connecting a Weather Sensor 5
- Power Failures..... 5

CONTROLLER PROGRAMMING AND OPERATION

- Watering Schedule Form 6
- Programming the Controller..... 7
 -  Setting the Date and Time..... 7
 -  Setting Watering Start Times..... 7
 - Eliminating a Program Start Time 7

Programming the Controller (Continued)

-  Setting Station Run Times (Length of Watering for Each Area)... 8
-  Setting Days To Water..... 8
- Selecting Specific Days of the Week to Water..... 8
- Selecting Interval Watering 8
-  Automatic 8
-  System Off 8
- Programmable Rain Off..... 9
- Bypass Weather Sensor 9
-  Seasonal Adjustment..... 9
-  Manually Run a Single Station 9
-  Manually Run All Stations 9-10
- One Touch Manual Start and Advance 10
- Hidden Features..... 10
- Programmable Delay Between Stations 10
- Clearing the Controller's Memory/Resetting the Controller 10

TROUBLESHOOTING AND SPECIFICATIONS

- Troubleshooting Guide 11-12
- Specifications..... 12
- CE Notice 13

EC COMPONENTS

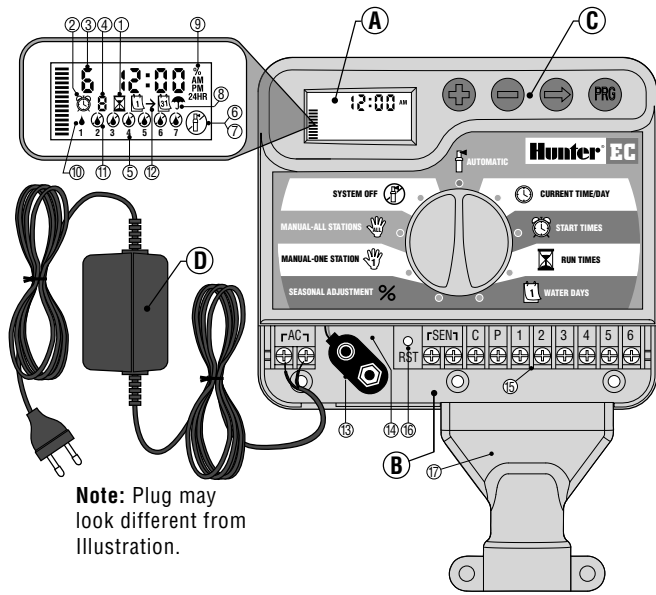





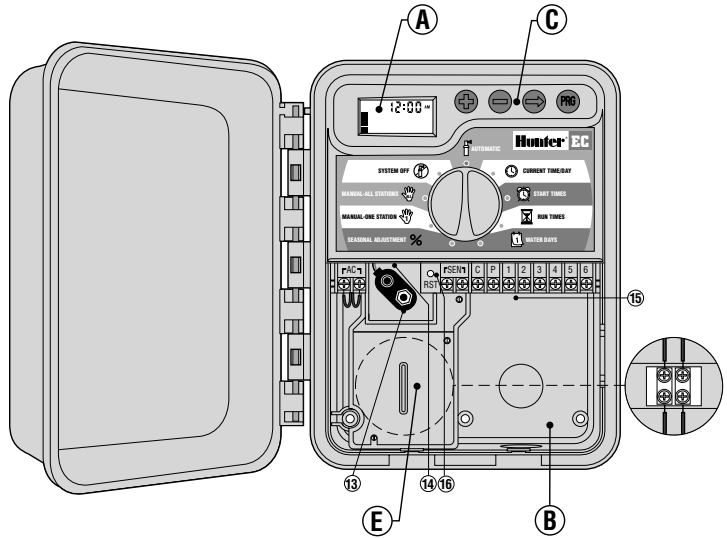



Note: Plug may look different from illustration.

Indoor Model



**Outdoor Model
(Internal Transformer Included)**

A – LCD Display

1.  **Run Times** – Allows user to set each valve station run time from 1 minute to 4 hours.
2.  **Start Times** – Allows 1 to 4 start times to be set in each program.
3. **Station Number** – Indicates currently selected station number.
4. **Program Designator** – Identifies program in use A, B, or C.
5. **Day of the Week** – Identifies day of the week (-E models will be indicated by number 1 to 7)
6. **Flashing Sprinkler** – Indicates that watering is occurring.
7.  **System Off** – Allows user to discontinue all programs and stop all watering. Also allows the user to set the controller to a timed off until dial is returned to the Automatic position.
8.  **Umbrella** – Indicates Rain Sensor is suspending irrigation.
9. **% Seasonal Adjustment** – Allows user to make run time changes according to the seasons without reprogramming. Bars on the left indicate seasonal adjustment percentage.
10.  **Rain Drop** – Indicates watering will occur on that selected day.
11.  **Crossed Rain Drop** – Indicates watering will NOT occur on selected day.
12.   **Calendar** – Indicates interval watering schedule is being programmed.





B – Wiring Compartment

13. **9-Volt Battery Connector** – The alkaline battery can be used to program the controller in the absence of AC power. Even without a 9-volt battery the EC will keep track of time for up to 1 month and retain the program indefinitely in the event of a power outage.
14. **Battery Compartment** – Compartment for the 9-volt battery.
15. **Terminal Strip Area** – Use to attach transformer and valve wires from their source to the controller.









16. **Reset Button** – Use to reset the controller.

17. **Conduit Cover** – Covers the field wires as they exit the conduit into the bottom of the controller.

C – Control Buttons

-  Button – Increases the selected flashing display.
-  Button – Decreases the selected flashing display.
-  Button – Advances the selected flashing display to the next item.
-  Button – Selects program A, B or C for different watering zone requirements.

Dial Settings

-  **Automatic** – Normal dial position for all controller automatic and manual operation.
-  **Current Time/Day** – Allows current day and clock time to be set.
-  **Start Times** – Allows 1 to 4 start times to be set in each program.
-  **Run Times** – Allows user to set each valve station run time from 1 minute to 4 hours.
-  **Water Days** – Allows user to select individual days to water or a selected number of days between waterings (interval).
- % Seasonal Adjustment** – Allows user to make run time changes according to the seasons without reprogramming. Bars on the left indicate seasonal adjustment percentage.
-  **Manual-One Station** – Allows user to activate a one time watering of a single valve station.
-  **Manual-All Stations** – Allows user to activate a one time watering of all valve stations or a few selected stations.
-  **System Off** – Allows user to discontinue all programs and stop all watering. Also allows the user to set the controller to a timed off until dial is returned to the Automatic position.

D – External Transformer (Indoor Model only)

A plug in transformer is provided to supply AC power to the controller.

MOUNTING THE CONTROLLER TO WALL



NOTE: The indoor EC is not water or weather resistant, and must be installed indoors or in a protected area.

1. Secure one 25 mm screw (A) into the wall. **Note: Install screw anchors if attaching to drywall or masonry wall.**
2. Slide the keyhole (B) on top of the controller over the screw.
3. Secure controller in place by installing screws in the holes (C) below the terminal strip area.



Do not plug transformer into power source until the controller is mounted and all valves have been connected.

Installing the Conduit Cover (For indoor controller installations)

The conduit cover is provided to cover the field wires as they exit the conduit into the bottom of the controller. The conduit cover can be used with ½" or ¾" diameter conduit.

To install the Conduit Cover:

1. Remove the lower access panel on the EC.
2. Slide the conduit cover on the bottom edge of the controller.

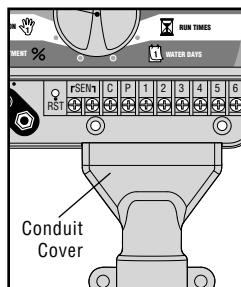

3. Bring the conduit and field wires to the bottom of the controller. Make sure that there is a sufficient length of conduit so it enters the conduit cover. There are two small notches on the left side of the cover to route the 24VAC wires from the external transformer, or wires from the sensor and P/MV (if applicable).
4. Secure the conduit cover to the wall with the screws and anchors provided.
5. Replace the lower access panel on the EC.

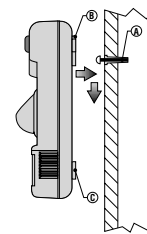

CONNECTING VALVES AND TRANSFORMER

1. Route control wires between valve location and controller. Typically it is recommended that at least 1 mm diameter conductor cable be used.
2. At the valves, attach the common wire to either solenoid wire of the valve. This is most commonly a white colored wire. Attach a separate control wire to the remaining solenoid wire and make a note of the color corresponding to each valve and the watering station it controls.
3. Secure the wires with a waterproof wire connector to protect the connection.
4. Secure the white valve common wire to the screw on the terminal marked C. Connect the color-coded wires from the valves to their appropriate station numbers and tighten the screws.

- 5. **Indoor model:** route transformer cable through the left side of the controller and connect the wires to the two screws marked AC.

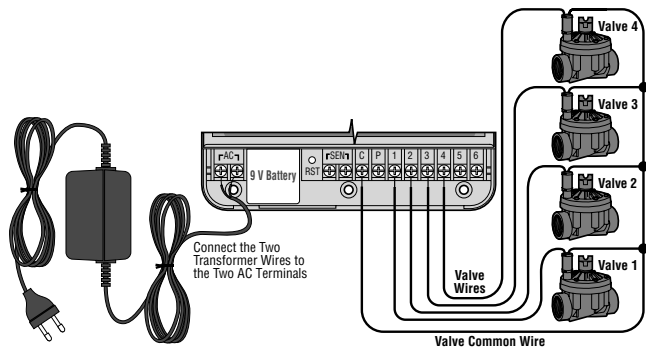

Outdoor model: transformer wires are already connected to the AC slots so all that is required is to connect primary power to the junction box from a power source.

E – High Voltage Wiring Compartment (Outdoor Model only)



NOTE: Outdoor model is water and weather resistant. Connecting the outdoor EC to the primary power should only be done by a licensed electrician following all local codes. Improper installation could result in shock or fire hazard.

Route AC power cable and conduit through the ½" (13 mm) conduit opening on the left side of the bottom of the cabinet and connect one wire to each of the two wires **inside the junction box**. Do not connect high voltage wires to the AC terminals inside the controller. Wire nuts are provided to make these wire connections. Note: For -E models, connect the wires to the AC terminal strip located inside the junction box.



Do not plug transformer into power source until the controller is mounted and all valves have been connected.

CONNECTING THE BATTERY

Connect a 9-volt alkaline battery (not included) to the battery wire clip located in the lower left-hand side of the controller. The battery will allow you to program the controller without AC power. However, the battery will not be able to activate any of the station valves. AC power must resume before watering will continue.

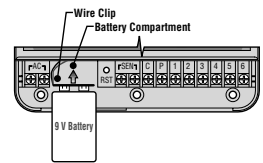

CONNECTING A MASTER VALVE



NOTE: Complete this section only if you have a master valve installed. A master valve is a “normally closed” valve installed at the supply point of the main line that opens only when the controller initiates a watering program.

1. At the Master Valve, attach the common wire to either solenoid wire of the valve. Attach a separate control wire to the remaining solenoid wire.
2. The common wire will still go to the screw slot marked C. The additional wire coming from the master valve will go in the screw slot marked P.

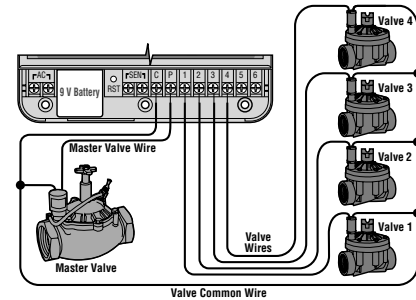

CONNECTING A PUMP START RELAY



NOTE: Complete this section only if you have a pump start relay installed. A pump start relay is a device that uses a signal from the controller to actuate a separate electrical circuit to energize a pump to provide water to your system.

The controller should be mounted at least 4.5 m away from both the pump start relay and the pump.

1. Route a wire pair from the pump relay into the controller housing.
2. Connect common wire to the screw slot C (Common) and the remaining wire from the pump relay to the P screw slot.

Relay holding current draw must not exceed .28 amps. Do not connect controller directly to pump—damage to controller can result.

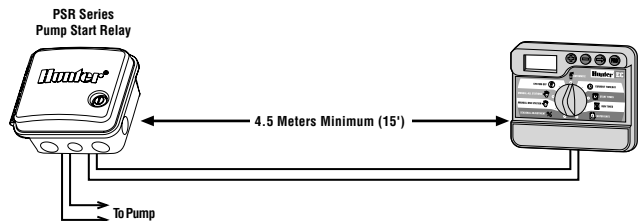

CONNECTING A WEATHER SENSOR

A Hunter weather sensor or other type of micro-switch weather sensor can be connected to the EC. The purpose of this sensor is to stop watering when weather conditions dictate.

1. Remove the jumper that is attached across the SEN terminals of the controller.
2. Connect one wire to the SEN terminal and one to the other SEN terminal.



NOTE: If the rain sensor is interrupting irrigation you can bypass it by using any of the following: **MANUAL-ONE STATION, MANUAL-ALL STATIONS, or ONE TOUCH START AND ADVANCE.** See section “Rain Sensor Bypass” for more information.

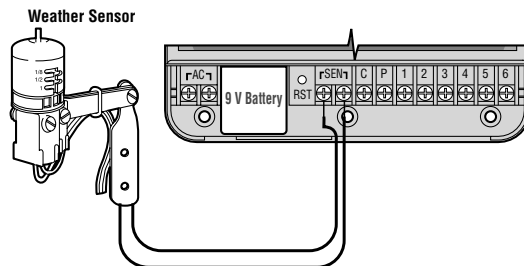

POWER FAILURES

Due to the possibility of power failures, the controller has non-volatile memory. Programmed information will never be lost. The controller will keep the correct time for up to 1 month without power. Normal watering will resume when AC power is restored.

WATERING SCHEDULE FORM

HUNTER EC		PROGRAM A							PROGRAM B							PROGRAM C							
DAY OF THE WEEK		1	2	3	4	5	6	7	1	2	3	4	5	6	7	1	2	3	4	5	6	7	
INTERVAL (Choose 1 to 31 days)																							
PROGRAM START TIMES		1																					
		2																					
		3																					
		4																					
STATION	LOCATION	STATION RUN TIME							STATION RUN TIME							STATION RUN TIME							
1																							
2																							
3																							
4																							
5																							
6																							
NOTES:																							

PROGRAMMING THE CONTROLLER

The EC display shows time and day when the controller is idle. The display changes when the dial is rotated to indicate the specific programming information to enter. When programming, the flashing portion of the display can be changed by pressing the **+** or **-** buttons. To change something that is not flashing, press the **➡** button until the desired field is flashing.

Three programs A, B and C each with the ability to have four daily start times, permit plants with different watering requirements to be separated on different day schedules.



NOTE: A basic programming rule is that whatever symbol or character is flashing will be the item programmed. For instance, if the hour is flashing when setting the time, the hour can be changed or programmed. For illustration purposes, flashing characters are in GRAY type.

Setting the Date and Time 🕒

1. Turn the dial to the **CURRENT TIME/DAY** position.
2. Hours will be flashing. Press the **+** or **-** button to change the hour shown on the display. Press the **➡** to proceed to setting the minutes.
3. Minutes will be flashing. Use the **+** or **-** button to change the minutes shown on the display. Press the **➡** to proceed to select AM, PM, or 24 hour time.
4. The time will be displayed, and an arrow will be flashing on AM. Press the **+** and **-** buttons to select AM, PM, or 24 hour. Press the **➡** to proceed to setting the day of the week.
5. The **number** for day 1 will be flashing. Press the **+** and **-** to select the day of the week corresponding to the day.

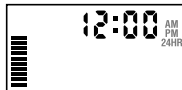

The time and day have now been set. You can turn the dial to **AUTOMATIC** to display the current time.

Setting Watering Start Times 🕒

1. Turn the dial to the **START TIMES** position.
2. The factory preset is set on program A. If necessary, you can select program B or C by pressing the **PRG** button.
3. Use the **+** or **-** button to change the start time. (The start times advance in 15 minute increments).
4. Press the **➡** button to select the next start time, or press **PRG** for the next program.

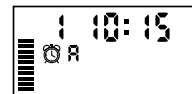
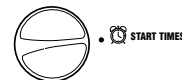

NOTE: One start time will activate all stations sequentially in that program. This eliminates the need to enter each station's start time. Multiple start times in a program can be used for separate morning, afternoon, or evening watering cycles.

Eliminating a Program Start Time

With the dial set to the **SET WATERING START TIMES** position, push the **+** or **-** button until you reach 12:00 am (Midnight). From here push the **-** button once to reach the OFF position.







PROGRAMMING THE CONTROLLER (cont.)



NOTE: If a program has all four-start times turned off, then that program is off. (All other program details are retained.) Because there are no start times, there will be no watering with that program. This is a convenient way to stop watering on one program only without turning the dial to the OFF position.





Setting Station Run Times (Length of Watering for Each Area)

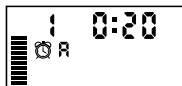

1. Turn the dial to the **RUN TIMES** position.
2. The display will show the last program selected (A, B or C) the station number selected, run time icon, and the run time for that station will be flashing. You can switch to another program by pressing the  button.
3. Use the  or  button to change the station run time on the display.
4. Press the  button to advance to the next station.
5. Repeat steps 3 and 4 for each station.
6. You can set station run times anywhere from 0 to 4 hours.
7. You can move between programs while staying on the same station. However, it is recommended that one program is completed before going on to the next program.







Setting Days To Water

1. Turn the dial to the **WATER DAYS** position.
2. The display will show the last program selected (A, B or C). You can switch to another program by pressing the  button.
3. The controller will display the seven days of the week with a  icon or a  icon above the numbered day. The  icon would represent an "On" water day, while a  icon would represent an "Off" watering day.



Selecting Specific Days of the Week to Water





1. With the  cursor on a specific day (the cursor always starts with 1), press the  button to activate a particular day of the week to water. Press the  button to cancel watering for that day. After pressing a button the cursor automatically advances to the next day.
2. Repeat step 1 until all desired days have been selected. The selected days will show with a  to indicate their status as **ON**. The last  is the last day of watering for that program.

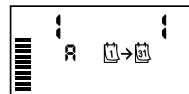

Selecting Interval Watering

With this option you can select interval watering from 1 to 31 days.



1. With the  cursor on day 7, press the  button until the two calendars and a flashing 1 appear in the display. Interval watering schedule appears on the display.
2. Press the  or  button to select the number of days between watering days (1 to 31). This is called the interval.

The controller will water the selected program at the next Start Time and will then water at the interval programmed.

Automatic

After programming is complete, turn the dial to **AUTOMATIC** to enable automatic execution of all selected programs and start times. Watering will not occur unless dial is in the **AUTOMATIC** position.



System Off

Valves currently watering will be shut off after the dial is turned to the **SYSTEM OFF** position for two seconds. All active programs are discontinued and watering is stopped. To return controller to normal automatic operation, simply return dial to **AUTOMATIC** position.



Programmable Rain Off

This feature permits the user to stop all programmed waterings for a designated period from 1 to 7 days. At the end of the programmable rain off period, the controller will resume normal automatic operation.

1. Turn the dial to the **SYSTEM OFF** position. Wait for **OFF** to be displayed.
2. Press **+** as many times as needed to set the number of days off desired (up to 7).
3. Turn the dial back to the **AUTOMATIC** position at which time, **OFF, a number** and the **DAYS** icon all remain on.

The days off remaining will decrease at midnight of each day. When it goes to zero, the display will show the normal time of day and normal irrigation will resume at the next scheduled start time.

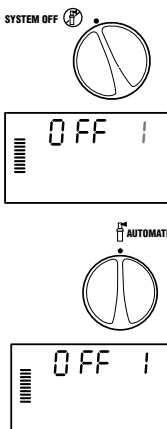

Bypass Weather Sensor

If the weather sensor is interrupting irrigation, you can bypass it by using the manual watering options described below. The dial positions **MANUAL-ONE STATION** and position **MANUAL-ALL STATIONS** as well as the One Touch Start and Advance process will successfully bypass the rain sensor.

Seasonal Adjustment %

Seasonal Adjust is used to make global run time changes without re-programming the entire controller. To use the seasonal adjustment feature:

1. Turn the dial to the **SEASONAL ADJUSTMENT** position.
2. The display will now show a flashing number followed by a %, as well as the bar graph which always remains on the display. Press the **+** or **-** buttons to adjust the percentage of the seasonal adjustment. Each bar on the graph represents 10%. This feature can adjust the controller from 10% to 150% of the original program.



To view the new adjusted run times, simply turn the rotary dial to the **SET STATION RUN TIMES** position, the displayed run time will be updated accordingly as the seasonal adjustment is made.



NOTE: The controller should always be initially programmed in the 100% position.

Manually Run a Single Station

1. Turn dial to the **MANUAL-ONE STATION** position.
2. Station run time will flash in the display. Use the **➡** button to move to the desired station. You may use the **+** or **-** button to select the amount of time for a station to water.
3. Turn the dial clockwise to the **AUTOMATIC** position to run the station (only the designated station will water, then the controller will return to automatic mode with no change in the previously set program). Also see **One Touch Manual Start and Advance** on page 10.



Manually Run All Stations

1. Turn dial to **MANUAL-ALL STATIONS**.
2. Select program A, B, or C by pressing the **PRG** button.
3. Press the **➡** button until desired starting station is displayed.
4. Station run time will flash in the display. Use the **+** or **-** button to select the amount of run time for the station to water if different from the run time displayed.
5. Use the **➡** button to move to the next station.
6. Repeat steps 3 and 4 to customize each station if desired.
7. Press the **➡** button until you reach the station that you would like watering to begin.









- Return dial to **AUTOMATIC** (program will water the entire program beginning with the station number last left in the display, then controller will return to automatic mode with no change in the previously set program).



NOTE: The station that is on the display when you turn the dial to AUTOMATIC will be the first station to run. The controller will then proceed to water in sequential order only. It will not water previous stations.

One Touch Manual Start and Advance







You can also activate all stations to water without using the dial.

- Hold down the  button for 2 seconds.
- This feature automatically defaults to program A. You can select program B or C by pressing the  program.
- The station number will be flashing. Press the  button to scroll through the stations and use the  or  button to adjust the station run times. (If no buttons are pressed for a few seconds during step 2 or 3, the controller will automatically begin watering.)
- Press the  button to scroll to the station you wish to begin with. After a 2 second pause, the program will begin.

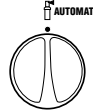
HIDDEN FEATURES





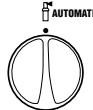

Programmable Delay Between Stations

This feature allows the user to insert a delay between when one station turns off and the next station turns on.

- Start with the dial in the **AUTOMATIC** position. 
- Press and hold the  button down while turning the dial to the **SET STATION RUN TIMES** position. 
- Release the  button. At this point the display will show a delay time for all stations in seconds, which will be blinking. The **DELAY** icon shall also be lit at this time. 
- Press the  and  buttons to increase or decrease the delay time between 0 and 1 minute 40 seconds in 5 second increments. 
- Return the dial to the **AUTOMATIC** position.

Clearing the Controller's Memory/Resetting the Controller

If you feel you have misprogrammed the controller, there is a process that will reset the memory to factory defaults and erase all programs and data that has been entered into the controller.

- Press and hold down the ,  and  buttons.
- Press and release the reset button in the lower wiring compartment.
- Release the ,  and  buttons. The display should now show 12:00 am. All the memory has been cleared and the controller may now be reprogrammed.

TROUBLESHOOTING GUIDE

PROBLEM	CAUSES	SOLUTIONS
Display indicates watering but none is occurring.	Faulty or miswired valve. Faulty pump or pump relay. No water pressure to system.	Check valve and valve wiring. Check pump and pump relay. Replace if defective. Turn on main system water supply.
Display is blank.	No AC power reaching controller.	Verify AC power and wiring. Correct any errors.
Display is blank with AC power to terminal and with a new battery.	Controller may be damaged by power surge.	Call your dealer or Hunter installer.
Time of day display is blinking.	Unit has just been powered up for the first time. Extended power outage has occurred that has drained backup battery.	Set time/date. Replace battery and reprogram controller.
Valve will not turn on.	Short in wire connections. Bad solenoid	Check wiring for short or faulty wire connections. Replace solenoid.
Display shows “ERR” with a number (1-6).	Short in valve wiring circuit; or a faulty solenoid on the station number indicated.	Check wire circuit or solenoid for the valve number indicated. Repair short or replace solenoid. Press any button to clear “ERR” display.
Display shows “P ERR”.	Faulty pump relay or master valve wiring. Incompatible or defective pump relay.	Check wiring to relay or master valve solenoid. Press any button to clear “P ERR” from the display. Check electrical specifications of pump relay. Replace if defective.
The display reads “No AC”.	There is no AC power present.	Check to make sure power is on. Check to see if transformer is properly installed.
Rain Sensor does not suspend irrigation.	Rain sensor is defective or miswired. Jumper not removed.	Verify operation of sensor and proper wiring. Remove jumper.
Frozen Display, or display showing incorrect information.	Power surge.	Reset controller per page 10 “Clearing Controllers Memory/Resetting the Controller”.

TROUBLESHOOTING GUIDE (cont.)

PROBLEM	CAUSES	SOLUTIONS
Automatic irrigation does not start at start time and controller is not in the system off mode.	AM/PM of time of day not set correctly. AM/PM of start time not set correctly. Start time is disabled (Set for Off). Controller is not receiving AC power.	Correct AM/PM of time of day. Correct AM/PM of start time. Set start time. See “ Setting Watering Start Times ”. Check AC connections.
Controller waters the same area more than one time/Controller cycles continuously.	Too many start times entered in program (user error).	One start time activates a complete cycle. See “ Setting Watering Start Times ”.

SPECIFICATIONS

Operating Specifications

- Station Run Time: 0 to 4 hours in 1-minute increments.
- Start Times: 4 per day, per program, for up to 12 daily starts.
- Watering Schedule: 7-day calendar or interval (1 to 31 day) programming.
- AM/PM or 24 hour clock option.
- Start time stacking.
- Simple manual operation, including 1 button manual operation.
- Seasonal Adjustment: 10 to 150% in 10% increments.

Electrical Specifications

- Transformer Input: 230/240VAC, 50/60Hz International Use.
- Transformer Output: 24VAC, 0.625 Amps.
- Station Output: 24VAC, .28 Amps per station.

- Maximum Output: 24VAC, .56 Amps.
- Master Valve Output: 24VAC, .28 Amps.
- Battery: Not required for program backup. 9-volt alkaline battery (not included) may be used to program controller in absence of AC power.
- Electronic short circuit protection.
- Surge protection: primary MOV-type.
- Non-volatile memory for program data.
- Controller will track time for 4 weeks in event of a power outage (even without a 9 volt battery).
- Rain sensor override by manual operation.

CERTIFICATE OF CONFORMITY TO EUROPEAN DIRECTIVES

Hunter Industries declares that the irrigation controller Model EC complies with the standards of the European Directives of “electromagnetic compatibility” 87/336/EEC and “low voltage” 73/23/EEC.



Project Engineer



Hunter Industries Incorporated • The Irrigation Innovators

Internet: www.HunterIndustries.com
